

MECHANICAL SEAL
TBA



CAT008 ENG REV 12.09

The **TBA** is an ideal general-purpose seal for medium and high pressures on a wide range of duties.

The **TBA** is a single component seal, with pinned stationary seat type A, pressure balanced, with integral shaft sleeve, manufactured in accordance with UNI EN 12756 (ex DIN 24960) and it is suitable for rotation in both directions.

It is fitted with a wave spring located outside the product, making it suitable for use in particularly dirty or viscous liquids. It can be fitted on plain or parallel shafts/sleeves and is interchangeable with DIN unbalanced seals.

Two substantial, internal, hardened drive lugs ensure high performance even in the case of misalignment, vibration and cavitation.

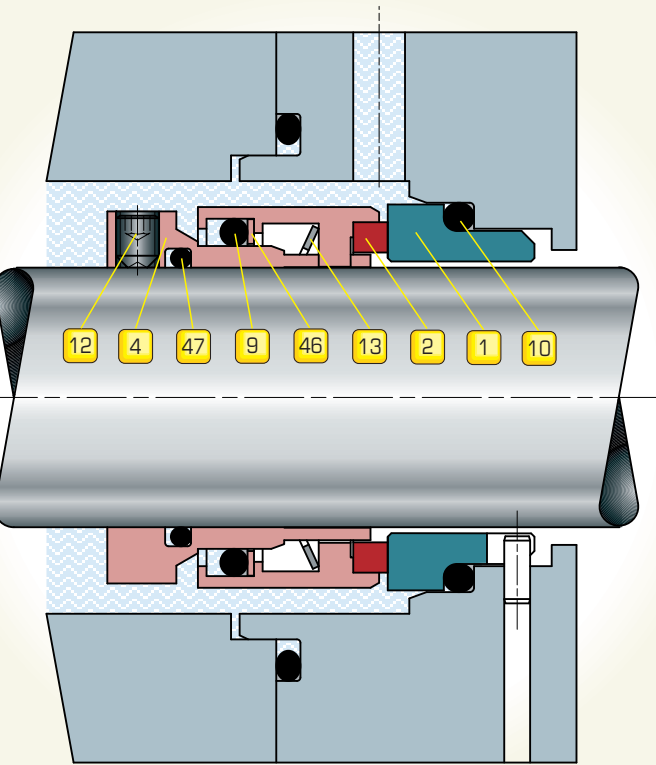









ELEMENTS:

- 1 STATIONARY SEAT
- 2 ROTARY FACE
- 4 SEAL BODY
- 9 ROTARY FACE "O" RING
- 10 STATIONARY SEAT "O" RING
- 12 SETSCREW
- 13 SPRING
- 46 BACK-UP RING
- 47 SEAL BODY GASKET

OPERATING CONDITIONS:

DIAMETER: (mm)	SPEED: (m/sec)	PRESSURE: (bar)	TEMPERATURE: (°C)
100 ↑ 20	20 ↑ 0	25 ↑ 0	+250 ↑ -100

CHARACTERISTICS:

-  SINGLE
-  BI-DIRECTIONAL
-  BALANCED
-  UNI EN 12756
-  DIRTY & VISCOUS LIQUIDS
-  CAN BE FITTED ON STRAIGHT SHAFT
-  UNIVERSAL APPLICATION
-  NON WETTED SPRING
-  RESISTANT TO MECHANICAL STRESS

STATIONARY SEAT: 1

SOLID TYPE A

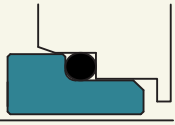

Cr-Mo Steel: **Y1**
Silicon Carbide: **U31**

STATIONARY SEAT "O" RING: 10

- Nitrile Rubber: **G**
- Ethylene Propylene: **D**
- Fluoroelastomer: **V**
- Perfluoroelastomer: **G711**
- PTFE: **T**

ROTARY FACE: 2

WITH INSERT

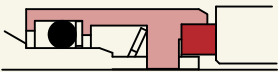

AISI 316+Graphite Resins impreg.: **Z32**
AISI 316+Silicon Carbide: **U32**
AISI 316+Tungsten Carbide: **X22**

ROTARY FACE AND BODY "O" RING: 9 47

- Nitrile Rubber: **G**
- Ethylene Propylene: **D**
- Fluoroelastomer: **V**
- Perfluoroelastomer: **G711**

SPRINGS: 13

Superstainless: **E9**

OTHER METAL PARTS: 4 12 46

AISI 316: **E**

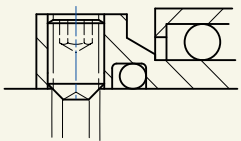

Pressure > 10 bar ⁽³⁾

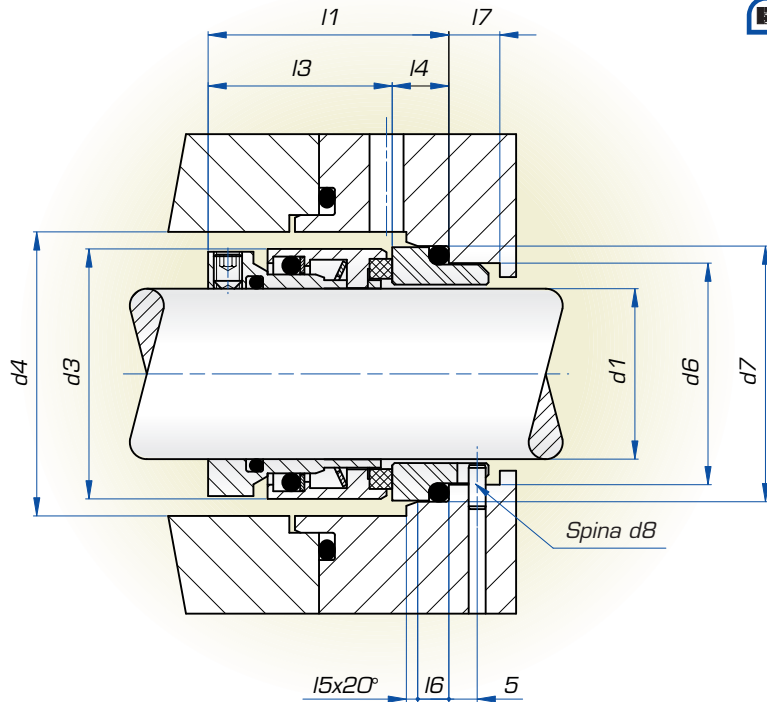

Seal Diameter	d1 h6	d3	d4 min.	d6 H11	d7 H8	d8	11 ± 0,5	13 ± 0,5	14	15	16	17
20	20	34	36	29	35	3	37,5	27,5	10	2	5	9
22	22	36	38	31	37	3	37,5	27,5	10	2	5	9
24	24	38	40	33	39	3	40	30	10	2	5	9
25	25	39	41	34	40	3	40	30	10	2	5	9
28	28	42	44	37	43	3	42,5	32,5	10	2	5	9
30	30	44	46	39	45	3	42,5	32,5	10	2	5	9
32	32	46	48	42	48	3	42,5	32,5	10	2	5	9
33	33	47	49	42	48	3	42,5	32,5	10	2	5	9
35	35	49	51	44	50	3	42,5	32,5	10	2	5	9
38	38	54	58	49	56	4	45	34	11	2	6	9
40	40	56	60	51	58	4	45	34	11	2	6	9
43	43	59	63	54	61	4	45	34	11	2	6	9
45	45	61	65	56	63	4	45	34	11	2	6	9
48	48	64	68	59	66	4	45	34	11	2	6	9
50	50	66	70	62	70	4	47,5	34,5	13	2,5	6	9
53	53	69	73	65	73	4	47,5	34,5	13	2,5	6	9
55	55	71	75	67	75	4	47,5	34,5	13	2,5	6	9
58	58	78	83	70	78	4	52,5	39,5	13	2,5	6	9
60	60	80	85	72	80	4	52,5	39,5	13	2,5	6	9
63	63	83	88	75	83	4	52,5	39,5	13	2,5	6	9
65	65	85	90	77	85	4	52,5	39,5	13	2,5	6	9
68	68	88	93	81	90	4	52,5	37,5	15	2,5	7	9
70	70	90	95	83	92	4	60	45	15	2,5	7	9
75	75	99	104	88	97	4	60	45	15	2,5	7	9
80	80	104	109	95	105	4	60	44,5	15,5	3	7	9
85	85	109	114	100	110	4	60	44,5	15,5	3	7	9
90	90	114	119	105	115	4	65	49,5	15,5	3	7	9
95	95	119	124	110	120	4	65	49,5	15,5	3	7	9
100	100	124	129	115	125	4	65	49,5	15,5	3	7	9

Dimensions subject to modifications without notice.

Example:

To order the seals shown on this page for shaft 25 mm and material shown in the table below:

2	1	9	10	47	13	4 12 46
Z32	U31	V2	V2	V2	E9	E

The code will be: TBA025 - Z32U31V2E9E ⁽⁴⁾

NOTES:

- 1) The material shown on this page is only part of the available range, for other products stock items, please call our Technical Sales Office.
- 2) The material should be chosen according to the operating conditions. All queries should be sent to our Technical Sales Office.
- 3) Blocking system with setscrew with the end cup-shaped in dimple shaft.
- 4) When the material of the seal on the stationary seat "O" ring is the same as the seal on the rotary face "O" ring the product code is not repeated.